

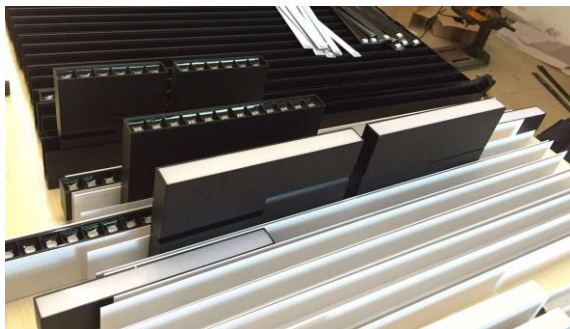

- Schönes und großzügiges lineares Design, DC 24V Power Rail System
- Das revolutionäre Produkt verwendet „Magnete“ anstelle herkömmlicher Befestigungselemente, um die einfachste verfügbare Installation zu erzielen
- Mit einer kompletten Auswahl an Zubehör, einfach DIY
- Geeignet für Büro-, Einzelhandelsgeschäfte, Hotels, Privathaushalte und andere öffentliche Bereiche - großartige gewerbliche oder private Anwendung
- Wir haben Spaß an der Auswahl und Installation des endgültigen Lichts, das wir im Inneren verwenden werden
- Durch die Installation des Schienenprofils können Sie die LED-Leuchten überall dort einsetzen, wo Sie Licht benötigen, und sie bewegen.
- Da die Vorrichtungen magnetisch installiert sind und keine mechanische Verriegelung vorhanden ist, ist das Verschieben oder Ersetzen von Vorrichtungen sehr einfach.

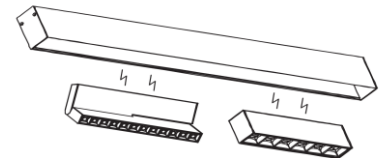

Anbau- Montage

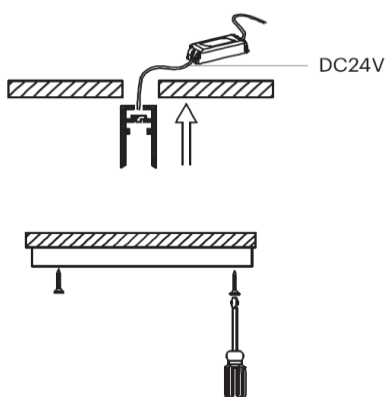

Einbau- Montage

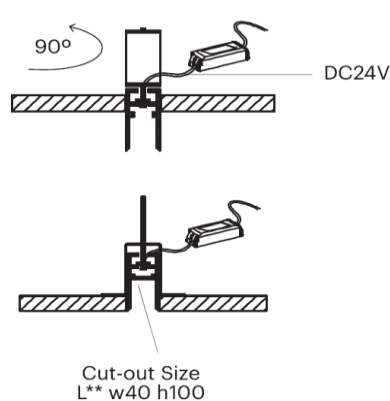

Pendel- Montage

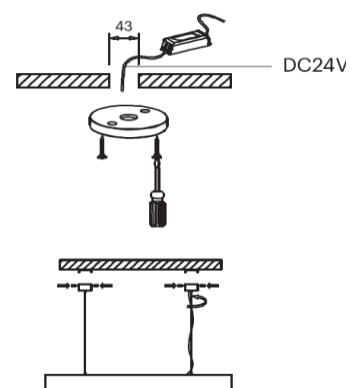

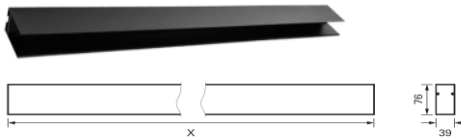

Track Länge: 1000mm#2000mm# 000mm

Magneto Track b i r für Innenräume Anbau/
Einbau/ Pendel Installation
sand weiss/ Sand schwarz



Spot50/ 15W
>80Ra DC24V

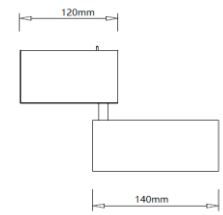

15°/ 36°/ 48° Abstrahlwinkel
Sand weiss/ Sand schwarz
2700k/ 3000k/ 4000k/ 5000k/ 6500k

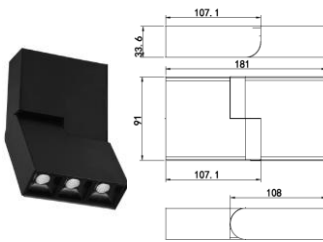

Fold03 12°/ 34°/ 48° Abstrahlwinkel
DC24V sand weiss/ sand schwarz
Osram 3*1W/ 5W >80Ra
2700k/ 3000k/ 4000k/ 5000k/ 6500k

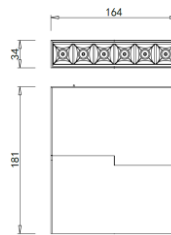

Flod06 12°/ 34°/ 48° Abstrahlwinkel
DC24V sand weiss/ sand schwarz
Osram 6*1W/ 6*2W >80Ra
2700k/ 3000k/ 4000k/ 5000k/ 6500k

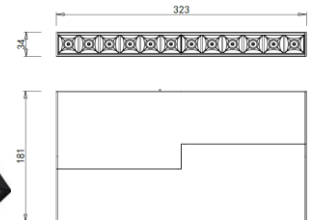

Flod12 12°/ 34°/ 48° Abstrahlwinkel
DC24V sand weiss/ sand schwarz
Osram 6*1W/ 6*2W >80Ra
2700k/ 3000k/ 4000k/ 5000k/ 6500k

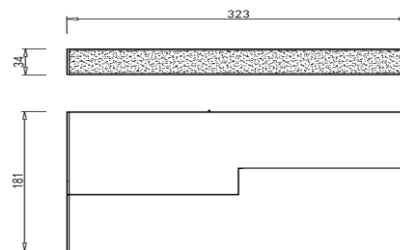

Fold32 323mm länge Diffuslicht
DC 24V Osram 10W >80Ra
2700k/ 3000k/ 4000k/ 5000k/ 6500k
sand weiss/ sand schwarz

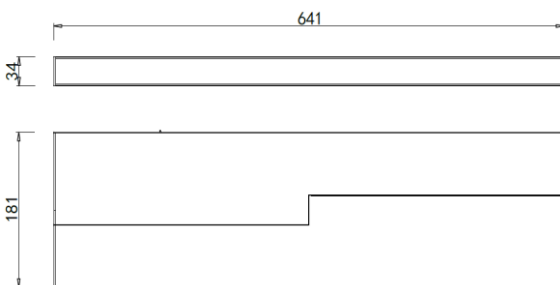

Fold64 640mm länge Diffuslicht
DC 24V Osram 20W >80Ra
2700k/ 3000k/ 4000k/ 5000k/ 6500k
sand weiss/ sand schwarz

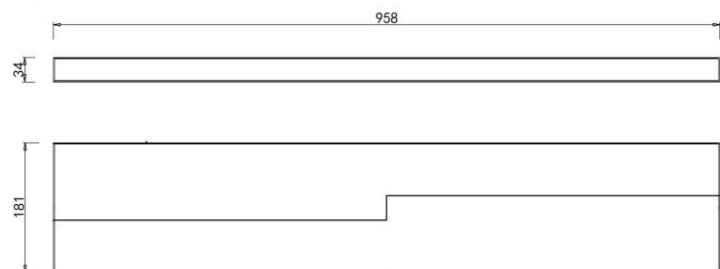

Fold96 959mm länge Diffuslicht
DC 24V Osram 30W >80Ra
2700k/ 3000k/ 4000k/ 5000k/ 6500k
sand weiss/ sand schwarz

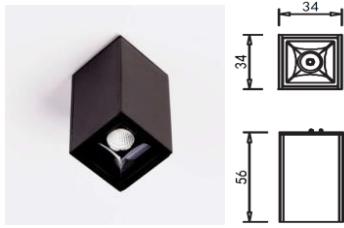

DOT01 12°/ 34°/ 48° Abstrahlwinkel
DC 24V sand weiss/ sand schwarz
Osram 1W >80Ra
2700k/ 3000k/ 4000k/ 5000k/ 6500k

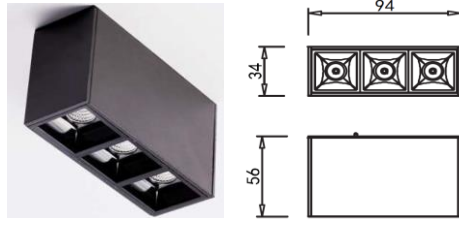

DOT03 12°/ 34°/ 48° Abstrahlwinkel
DC 24V sand weiss/ sand schwarz
Osram 4W >80Ra
2700k/ 3000k/ 4000k/ 5000k/ 6500k

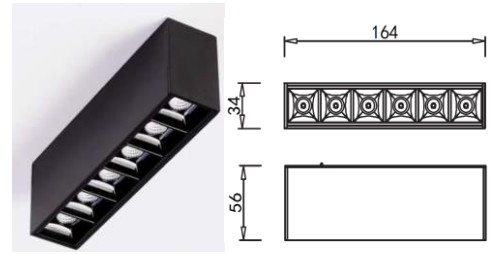

DOT06 12°/ 34°/ 48° Abstrahlwinkel
DC 24V sand weiss/ sand schwarz
Osram 8W >80Ra
2700k/ 3000k/ 4000k/ 5000k/ 6500k

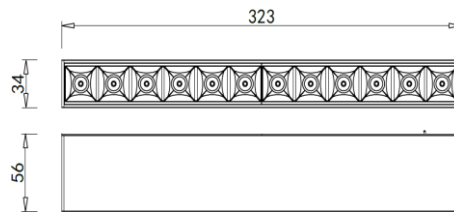

DOT12 12°/ 34°/ 48° Abstrahlwinkel
DC 24V sand weiss/ sand schwarz
Osram 16W >80Ra
2700k/ 3000k/ 4000k/ 5000k/ 6500k

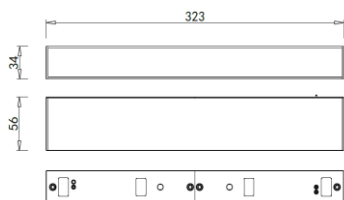

Linear32 323mm länge Diffuslicht
DC 24V Osram 15W >80Ra
2700k/ 3000k/ 4000k/ 5000k/ 6500k
sand weiss/ sand schwarz

Linear96 959mm länge Diffuslicht
DC 24V Osram 45W >80Ra
2700k/ 3000k/ 4000k/ 5000k/ 6500k
sand weiss/ sand schwarz

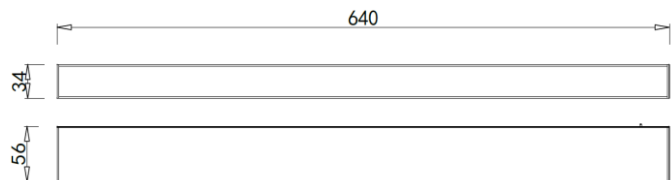

Linear64 640mm länge Diffuslicht
DC 24V Osram 30W >80Ra
2700k/ 3000k/ 4000k/ 5000k/ 6500k
sand weiss/ sand schwarz

